

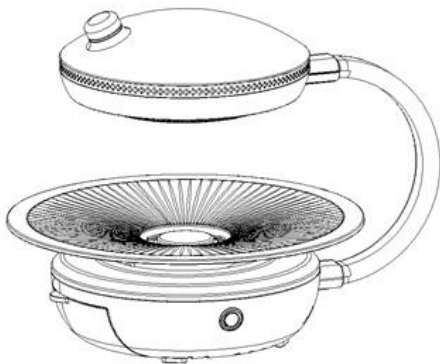

USER MANUAL



Model No.

SBG-MINI-W1

Your safety is our priority.

Please read the instructions carefully before operating the appliance for the first time.

Dearest Customer,

THANK YOU FOR YOUR PURCHASE & SUPPORT!

We hope that you can experience the best performance from our products which have been manufactured with excellent quality and state-of-the-art technology to bring out the KITH experience.

Please take some time to read this user manual to retain the appliance at its best performance and to extend the lifespan of the appliance. This manual provides all detailed instructions you may require ensuring safe usage, cleaning, and maintenance.

Happy grilling!

Please keep this user manual within easy reach for future references. Doing so will allow you to understand and take advantage of the appliance unique features at any time.

With Love,

Kith

CONTENTS

SAFETY GUIDELINES.....	4
PRODUCT OVERVIEW.....	5 - 9
Specifications.....	5
Features.....	5 - 6
Structure.....	7
Accessories.....	8
OPERATING OF APPLIANCES.....	9
CLEANING & MAINTENANCE SAFETY.....	10
WARRANTY & SERVICE.....	10

SAFETY GUIDELINES

1. This product is designed for household use only, not for commercial usage.
2. Please use a dedicated socket. Do not share the power plug with other electrical appliances.
3. Do not operate the appliance with a damaged cord or plug, or after the appliance malfunctions or has been damaged in any manner. Please return the appliance to *Casa (S) Pte Ltd, 15 Kian Teck Crescent 628884* to repair (only carry-in service)
4. Do not attempt repair, repair should be done only by authorised personnel.
5. Be cautious when touching and operating the product during and after cooking to avoid the risk of scalding. Best to wait once the appliance completely cools down.
6. Unplug from outlet when not in use, before cleaning, and before servicing. Allow to cool down before putting on, taking off parts, or before cleaning.
7. To protect against fire, electric shock, and personal injury do not sprinkle or immerse cord, plugs, or appliance in any liquids.
8. If you intend not to use the appliances for a longer time, switch off the product and unplug from the socket.
9. Ensure that product is operating on a flat, non-tilted surface.
10. Keep 30cm away from the wall.
11. Keep away from flammable and combustible material.
12. Never allow children, physically or mentally handicapped, people who lack experience or knowledge to operate, except that the person is responsible for ensuring its replacement and maintenance.
13. Close supervision is necessary when any appliance is used near children. Do not let children use, touch, or play with the machine.
14. Keep accessories out of the reach of children.

PRODUCT OVERVIEW

SPECIFICATIONS

Model :	SBG-MINI-W1
Product :	Radiant Grill
Rated Frequency :	50Hz
Rated Power:	1300W
Voltage:	220 – 240V
Product Dimensions :	H288mm x W373.4mm x D300mm
Net Weight :	2.1kg
Power :	650W & 1300W
Colour :	White

FEATURES

Multiple functions <i>(Depending on the accessories available)</i>	<ul style="list-style-type: none">• Grilling meat, fish and vegetables• Baking croissant, chips, custard, cookie, chiffon cake, pie, potato• Stir-fried rice, noodles, spaghetti• Fruitwood smoked meat• Pizza
Rapid-Infrared Heating Technology	<ul style="list-style-type: none">• Equipped with advanced & patented far-infrared heating technology using a powerful heat penetration to cook food from inside out

	<ul style="list-style-type: none"> Does not destroy food nutrient, makes food taste better and easier for body absorption
Zero Smoke <i>(99.9% Smokeless)</i>	<ul style="list-style-type: none"> Cooking food by far-infrared ray from the top allows the appliance to emit no smoke
Adjustable Temperature	<ul style="list-style-type: none"> Temperature is adjustable via the Control Panel 2 temperature settings – 650W & 1300W
Oil Collection Tray	<ul style="list-style-type: none"> Oil collection tray is located at the bottom of the appliance To collect the fat, oil and meat juices during cooking Dishwasher safe
Non-stick, Rotatable and Detachable Pan	<ul style="list-style-type: none"> Adopts imported non-stick coating technology making it easier to clean and it is dishwasher safe Rotating function for an even grilling and easy access to food Specially designed for the oil to flow down effortlessly to the oil collection tray
Convenient	<ul style="list-style-type: none"> Lightweight and easy to move around
Grilling Accessories	<ul style="list-style-type: none"> Offering options for various grilling needs Accessories available: Frying Pan, Silicon Ring, Baking Rack, Extender Ring

STRUCTURE

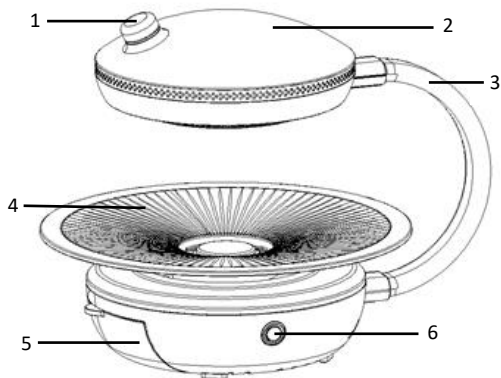







1 – Power Knob Control	4 – Grilling Pan (30cm)
2 – Lid	5 – Oil Tray
3 – Arm	6 – Auto-rotate Button

ACCESSORIES

Accessories are available to fully experience the grill.

**Please note that the accessories below can only be used on a 36cm grill pan. The grill pan that is included with this grill is 30cm.*

ACCESSORIES	DESCRIPTION
 Frying Pan	<ul style="list-style-type: none">To stir fry different types of food
 Silicone Ring	<ul style="list-style-type: none">Heat-resistant materialTo avoid getting scaled from accidental touches on the hot edges of the grill pan during cooking.
 Extender Ring	<ul style="list-style-type: none">Minimises hot oil spills during cookingDouble-layer cooking when used together with the Baking Rack (as shown below) 
 Baking Rack	<ul style="list-style-type: none">To smoke meat with fruitwoodDouble-layer cooking when used together with the Extender Ring (as shown below) 

To purchase accessories, please scan the QR Code below.



Operating of Appliances

1. Please ensure the product on a flat work surface.
2. Insert a clean pan downwards onto the base of the product (Fig. 1)

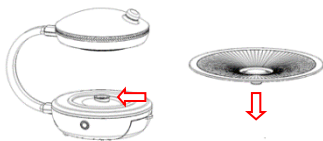

Fig. 1

3. Insert the plug into Power Socket. (Note: The voltage of socket must comply with product voltage)
4. To start operation, turn Power Knob (1) to the desired power. The appliance and the heating element will start heating.
5. Allow the heating element to heat the appliance for 5 minutes before putting any food on the rotating plate.
6. The rotating function can be turned on by pressing the Auto-rotate button (6). Press again to stop auto-rotating.
7. The temperature can be adjusted anytime while the appliance is operating.
8. After using the appliance, turn the Power Knob (1) back to 'OFF'. The device will enter into Cooldown Mode and the cooling fan will start cooling down the appliance. We recommend to leave the fan run for 8 minutes before turning the main switch off.
9. The main power supply can be turned off only after the machine cools down completely.

Cleaning & Maintenance Safety

1. Before cleaning and maintenance, unplug the appliance and ensure the appliance's surface temperature is cooled to room temperature.
2. Do not use abrasive or aggressive agents for cleaning as the product surface/non-stick coating may be damaged.
3. Remove the grill pan from the main body. Rinse the grill pan with warm water. Use a warm cloth to wipe the body
4. Remove the oil tray from underneath the base. Discard the excess grease and clean the oil tray by hand or dishwasher.
5. Use a warm cloth to wipe the body. Do not directly rinse with water.
6. As for the tricky stains, use neutral detergent and allow it to sit for at least 10 minutes. Then, wipe with a soft and lukewarm cloth later.

WARRANTY & SERVICE

If the purchase is made from Casa e-Shop, your warranty is automatically activated.

Otherwise, please scan the QR Code to the "Warranty Registration" page.



Casa (S) Pte Ltd. reserves the rights to the final interpretation of the content of this manual. Customer will not be notified in the event of any amendments to the content.

The manufacturer and agent decline all responsibilities in the event of damage caused by improper, incorrect or illogical use of the appliance.

Contact after-sales service centre when in doubt of the condition of the appliance.

► For Customer Care, please contact -

WhatsApp: 9842 6322

Email: kith@casa.com.sg

► For After-Sales Service [Singapore], please contact -

Casa (S) Pte Ltd

15, Kian Teck Crescent, Singapore 628884

Telephone: +65 6268 0077

Fax: +65 6898 0510

Email: service@casa.com.sg